

Revision Record					
Control No.	Revision	Description	Date	Drawn	Approved
	A0	I TMA -0530-4R7-M	2018/10/23	H	R
	A1	A TMA -0530-100-M	2018/10/29	H	R
	A2	A TMA -0530-1R0-M	2018/11/14	H	R
	A3	A TMA -0530-R33-M TMA -0530-R68-M TMA -0530-2R2-M TMA -0530-3R3-M TMA -0530-6R8-M	2018/11/21	H	R

T-0530-2 X-MU Inductor Power Inductor

Feature

- L
- L DCR
- H
- H (I)
- R HS

Recommend Land Pattern Dimensions

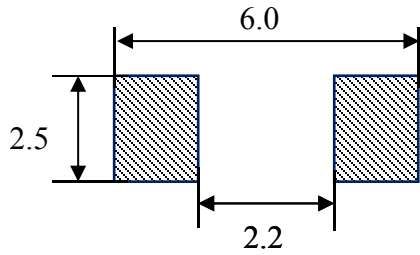

Marking

- T 3-
- F : 1R0 1.0 H, R10 0.1 H.

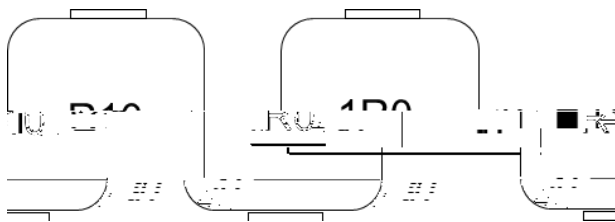

Inductance:
1.0 μ H

Specifications

Part No.	Inductance		DCR (m)		Saturation Current	Heat Rating Current
	L ₀ (μ H)	Tolerance	Typ.	Max.	Isat (Amps.)	Idc (Amps.)
					Typ.	Typ.
TMA -0530-R33-M	0.33	20%	4.55	5.15	19	14
TMA -0530-R68-M	0.68	20%	9.0	10.0	13	11
TMA -0530-1R0-M	1.0	20%	12	13.5	11	9.0
TMA -0530-2R2-M	2.2	20%	25	29	9.0	6.5
TMA -0530-3R3-M	3.3	20%	33	38	8.0	5.5
TMA -0530-4R7-M	4.7	20%	51	60	6.0	4.5
TMA -0530-6R8-M	6.8	20%	80	90	4.5	3.5
TMA -0530-100-M	10.0	20%	110	125	4.0	3.0

Notes:

1. A 23 3 C 45%RH 70%RH
2. T I : 3260B LCR M , 3265B B C S (100 H, 1), EUCOL USE
- DC L
3. O - 55 C + 125 C (+ -)
4. I : DC (A) L₀ 30 %.
5. I : DC (A) T 40 C.
6. T (+) 125 C
- . C , , P B , P
7. T

Inductance and Temperature Rise vs. DC Current

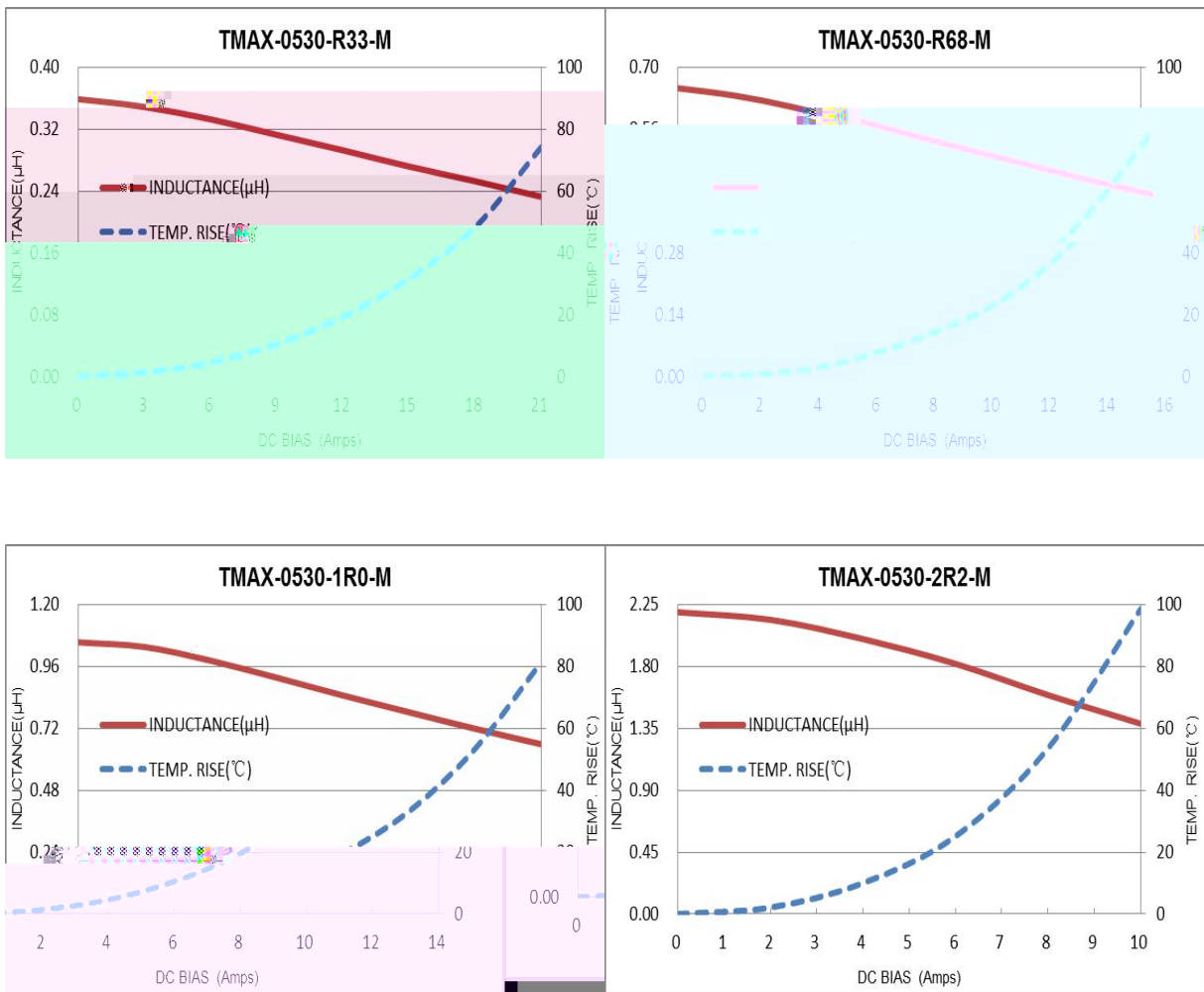

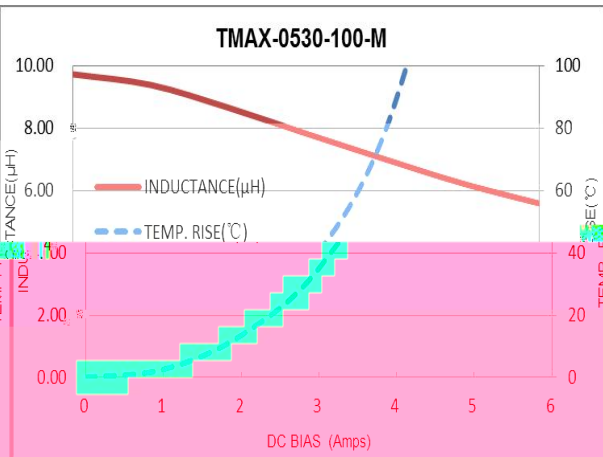
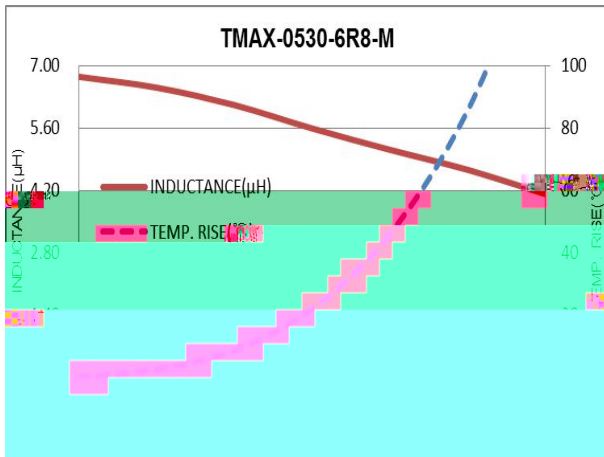
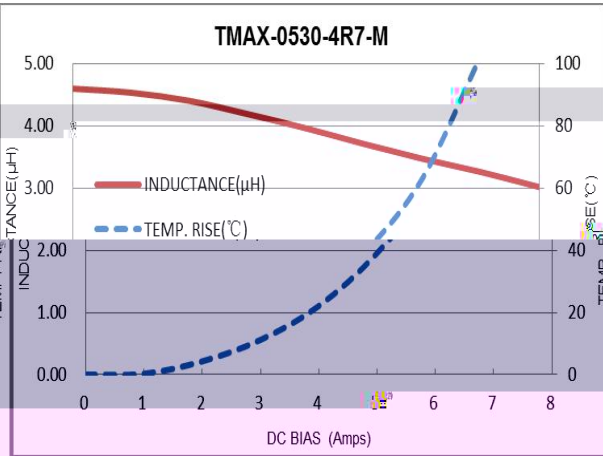
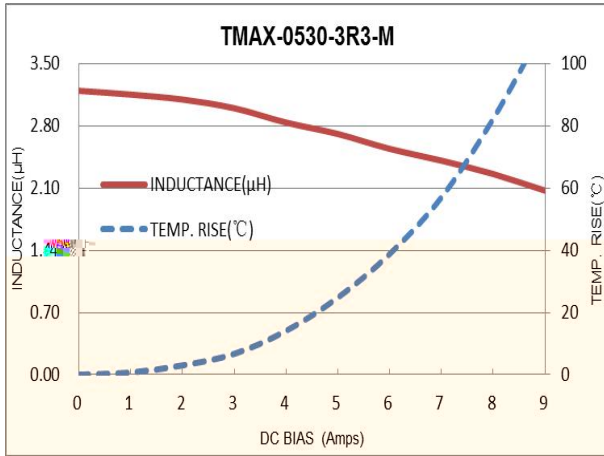

Reliability:

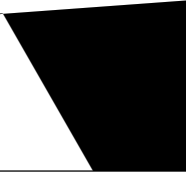
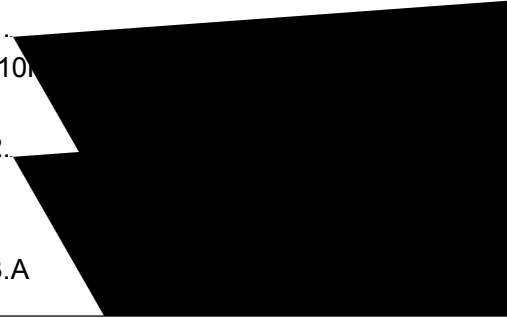
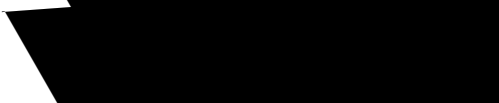
Item	Test Method	Specification and Requirement
S	S : 1.P : 160 ± 10 C 90 2.R : 245 ± 5°C 2 ± 0.5	T 95%
	1.  (10) 2.  3.A	L/L ₀ ± 5% N
S	1.P : 100 G 2.D : 11 3.3 3	

Reliability:

Item	Test Method	Specification and Requirement
T S	1.R 100 : (-55 ± 2 C, 30 ± 3) → (R , 5) → (+125 ± 2 C, 30 ± 3) → (R , 5) 2.R : 48 + 4 / - 0	L/L ₀ ± 5% N
H T R	1.E T : 85 ± 2 C 2.A C : R 3.D : 1,000 + 4 / - 0	
H R	1.E T : 60 ± 2 C 2.R H : 90 95% 3.D : 1,000 + 4 / - 0	
L T S	1.S : -55 ± 2 C 1,000 + 4 / - 0	
H T S	1.S : +125 ± 2 C 1,000 + 4 / - 0	

Packaging Dimensions

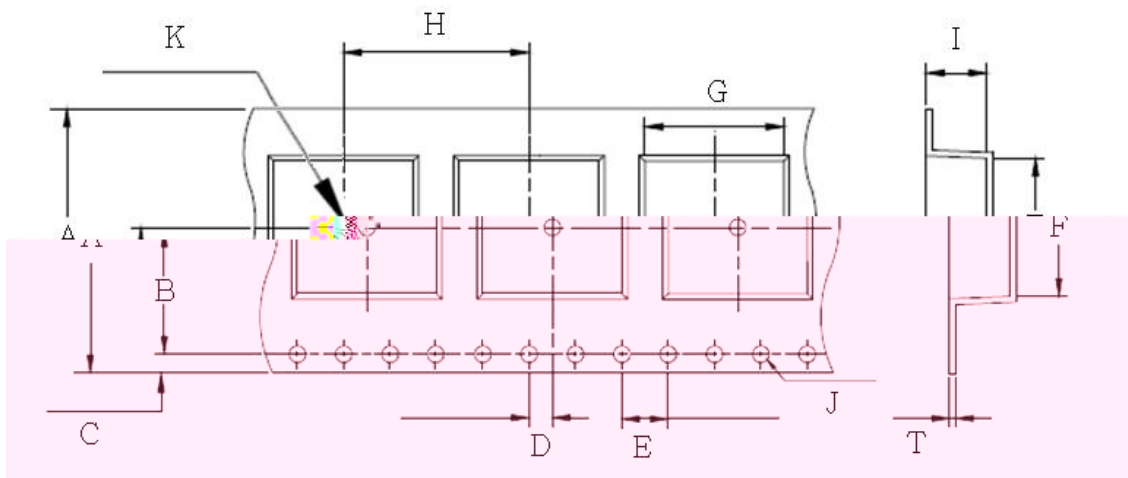

G	F	I	T	H	A
5.4 ± 0.1	5.8 ± 0.1	3.5 ± 0.15	0.35 ± 0.05	8.0 ± 0.1	12 ± 0.2
J	K	D	E	B	C
1.5 ± 0.1	1.5 ± 0.1	2.0 ± 0.1	4.0 ± 0.1	5.5 ± 0.1	1.75 ± 0.1

Reel Dimensions

A	B	C
12.5 ± 0.2	2.0 ± 0.2	B

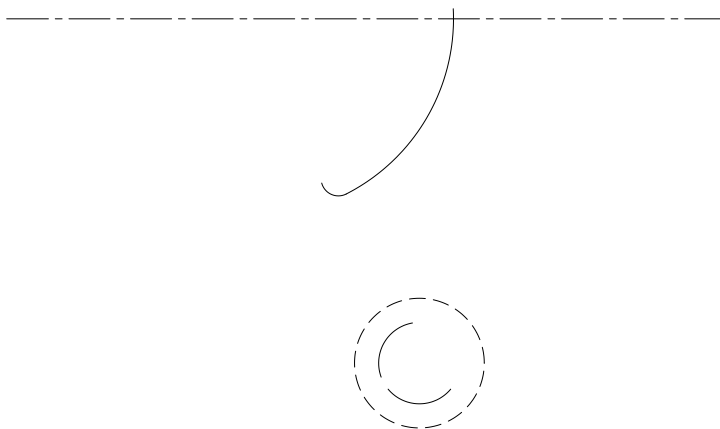

Peeling of top cover tape

- T 300 / .
- T 0.1 0.7 N.

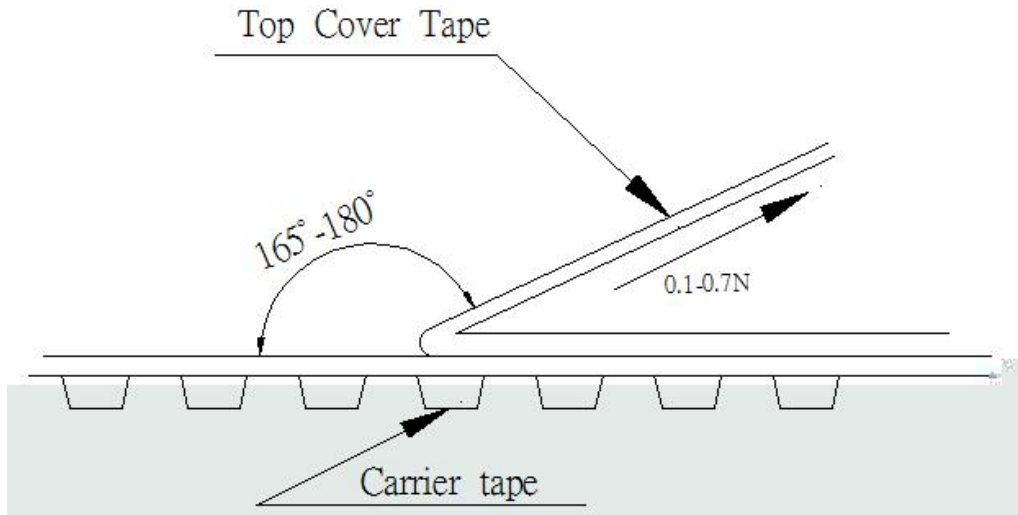

Reflow Profile

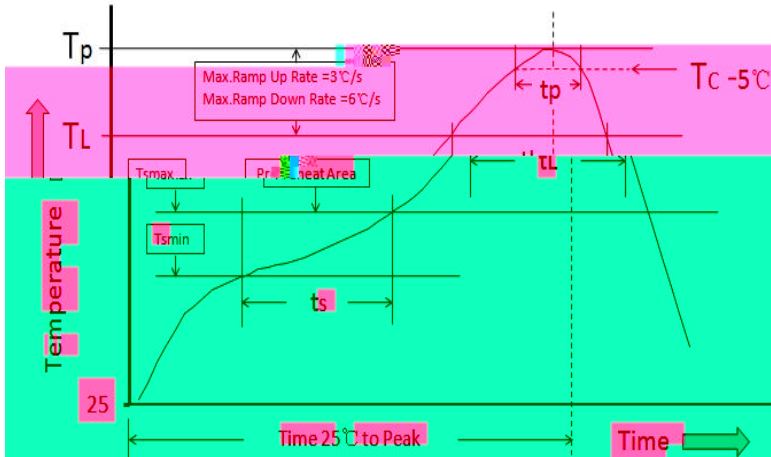

Table1-StandardSnPb Solder(Tc)

Package Thickness Volume
mm mm³ lu



Numbers of taping

- 2,000 /

Label marking

Care note for Safety

➤ P A C
T

, - - , .T ,
, ,

/ , , .

➤ T R
T

.I .

➤ D S
D

.

➤
T ,
. .

➤ P
I ,
.P .

➤ D
P .

➤ N
T

(, ,) ..TDG H C .,L .
- .I ,